

### 电源输入接口

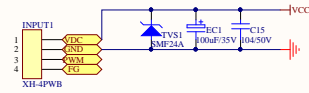

### 无刷电机驱动模块

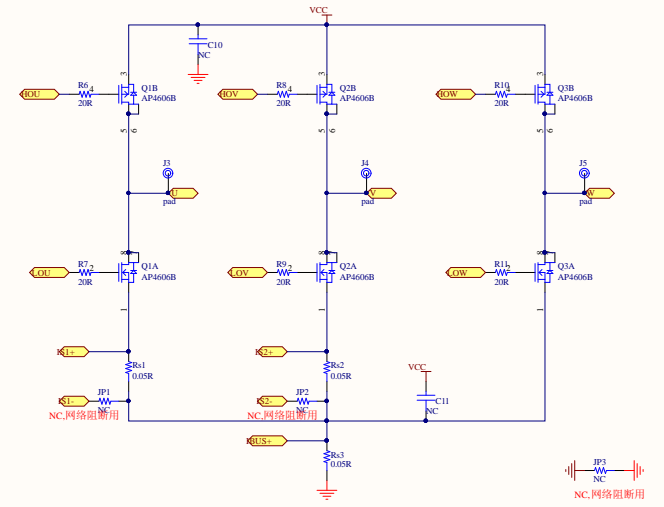
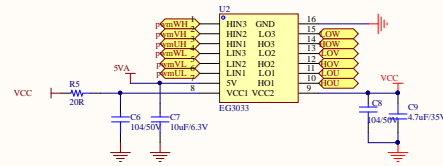

### MCU主控部分

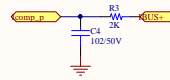
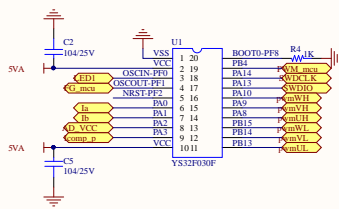
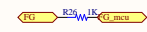
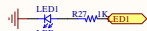
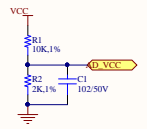

### 运放电路

#### 电流采样差分走线

